



E22-400T22D User Manual

SX1268 433/470MHz 160mW LoRa Wireless Module



CONTENTS

1. OVERVIEW.....	3
1.1 INTRODUCTION.....	4
1.2 FEATURES.....	4
1.3 APPLICATION.....	5
2. SPECIFICATION AND PARAMETER.....	5
2.1 LIMIT PARAMETER.....	5
2.2 OPERATING PARAMETER.....	5
3. SIZE AND PIN DEFINITION.....	7
4. CONNECT TO MCU.....	8
5. FUNCTION DESCRIPTION.....	9
5.1 FIXED TRANSMISSION.....	9
5.2 BROADCASTING TRANSMISSION.....	9
5.3 BROADCASTING ADDRESS.....	9
5.4 MONITOR ADDRESS.....	10
5.5 RESET.....	10
5.6 AUX DESCRIPTION.....	10
5.6.1 Indication of UART output.....	10
5.6.2 Indication of wireless transmitting.....	11
5.6.3 Configuration procedure of the module.....	11
5.6.4 Notes for AUX.....	11
6. OPERATING MODE.....	12
6.1 MODE SWITCHING.....	12
6.2 NORMAL MODE (MODE 0)	13
6.3 WOR MODE (MODE 1)	13
6.4 CONFIGURATION MODE (MODE 2)	13
6.5 DEEP SLEEP MODE (MODE 3)	14
7. REGISTER READ AND WRITE CONTROL.....	14
7.1 COMMAND FORMAT.....	14
7.2 REGISTER DESCRIPTION.....	15
7.3 FACTORY DEFAULT PARAMETER.....	17
8. REPEATER NETWORKING MODE.....	18

9. CONFIGURATION INSTRUCTIONS ON COMPUTER.....	19
10. HARDWARE DESIGN.....	20
11. FAQ.....	21
11.1 COMMUNICATION RANGE IS TOO SHORT.....	21
11.2 MODULE IS EASY TO DAMAGE.....	21
11.3 BER(BIT ERROR RATE) IS HIGH.....	21
12. WELDING GUIDANCE.....	22
13. E22 SERIES.....	22
14. ANTENNA GUIDANCE.....	22
14.1 ANTENNA RECOMMENDATION.....	22
REVISION HISTORY.....	23
ABOUT US.....	23

Disclaimer

EBYTE reserves all rights to this document and the information contained herein. Products, names, logos and designs described herein may in whole or in part be subject to intellectual property rights. Reproduction, use, modification or disclosure to third parties of this document or any part thereof without the express permission of EBYTE is strictly prohibited.

The information contained herein is provided “as is” and EBYTE assumes no liability for the use of the information. No warranty, either express or implied, is given, including but not limited, with respect to the accuracy, correctness, reliability and fitness for a particular purpose of the information. This document may be revised by EBYTE at any time. For most recent documents, visit www.ebyte.com.

1. Overview

1.1 Introduction

E22-400T22D is a wireless serial port module (UART) based on SEMTECH's SX1268 RF chip. It has multiple transmission modes, working in the 410.125MHz~493.125MHz, frequency (default 433.125MHz), LoRa spread spectrum technology, TTL level output, compatible with 3.3V and 5V IO port voltage.



E22-400T22D uses a new generation of LoRa spread spectrum technology. Compared with the traditional SX1278 solution, the SX1268 solution has a longer transmission distance, faster speed, lower power consumption and smaller size. It Supports wake-up over air, wireless configuration, carrier monitoring, automatic relay, communication key and other functions, supports sub-package length setting, and can provide custom development services.

1.2 Features

- Develop a new LoRa spread spectrum modulation technology based on SX1268, which will bring longer communication distance and stronger anti-interference ability;
- Support automatic relay networking, multi-level relay is suitable for ultra-long distance communication, multiple networks running in the same area are running simultaneously;
- Support users to set their own communication keys, which cannot be read, greatly improving the confidentiality of user's data;
- Support LBT function, monitor the channel environmental noise before sending, which can greatly improve the communication success rate of the module in harsh environments;
- Support RSSI signal strength indication function for evaluating signal quality, improving communication network, ranging;
- Support wireless parameter configuration, send command data packets wirelessly, remotely configure or read wireless module parameters;
- Support wake-up over air, that is, ultra-low power consumption function, suitable for battery-powered applications;
- Supports fixed-point transmission, broadcast transmission, and channel monitoring;
- Supports deep hibernation, and the whole machine consumes about 2uA in this mode;
- Support the global license-free ISM 433MHz band and 470MHz meter reading frequency band;
- Under ideal conditions, the communication distance can reach 5km;
- The parameters are saved when power off, and the module will work according to the set parameters after power on again;
- Efficient watchdog design, once an exception occurs, the module will automatically restart and continue to work according to the previous parameter settings;
- Support data transmission rate of 0.3k ~ 62.5kbps;
- Support 2.3 ~ 5.5V power supply, power supply over 5V can ensure the best performance;
- Industrial grade standard design, support long-term from at -40 ~ +85 °C;
- The size and shape are consistent with our E32 series modules, which can be directly replaced to improve product performance and distance.

1.3 Application

- Home security alarm and remote keyless entry ;
- Smart home and industrial sensors ;
- Wireless alarm security system ;
- Building automation solutions ;
- Wireless industrial-grade remote control ;
- Health care products ;
- Advanced Meter Reading Architecture(AMI) ;
- Automotive industry applications.

2. Specification and parameter

2.1 Limit parameter

Main parameter	Performance		Remark
	Min.	Max.	
Power supply (V)	0	5.5	Voltage over 5.5V will cause permanent damage to module
Blocking power (dBm)	-	10	Chances of burn is slim when modules are used in short distance
Operating temperature (°C)	-40	+85	Industrial grade

2.2 Operating parameter

Main parameter	Performance			Remark
	Min.	Typ.	Max.	
Operating voltage (V)	2.1	5.0	5.5	≥ 3.3 V ensures output power
Communication level (V)	-	3.3	-	For 5V TTL, It is recommended to add level conversion
Operating temperature (°C)	-40	-	85	Industrial design
Operating frequency (MHz)	410.125	433.125	493.125	Support ISM band
Power consumption	TX current (mA)	-	110	Instant power consumption
	RX current (mA)	-	12	-
	Sleep current (μ A)	-	2	Software is shut down
Max Tx power (dBm)	21.5	22.0	22.5	-
Receiving sensitivity (dBm)	-146	-147	-148	Air data rate is 0.3 kbps
Air data rate (bps)	0.3k	2.4k	62.5k	Controlled via user's programming

Main parameter	Description	Remark
Distance for reference	5km	Test condition : clear and open area, antenna gain: 5dBi, antenna height: 2.5m, air data rate: 2.4kbps
TX length	240 Byte	Can be configured via command as 32/64/128/240 bytes per packet to transmit
Buffer	1000 Byte	-
Modulation	LoRa	New generation LoRa modulation technology
Communication interface	UART	TTL level
Package	DIP	-
Connector	1*7*2.54mm	-
Size	21*36 mm	-
Antenna	SMA	50 ohm impedance

3. Size and pin definition

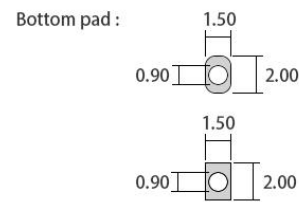
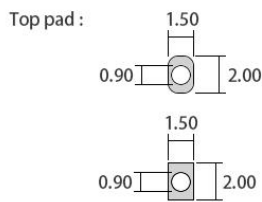
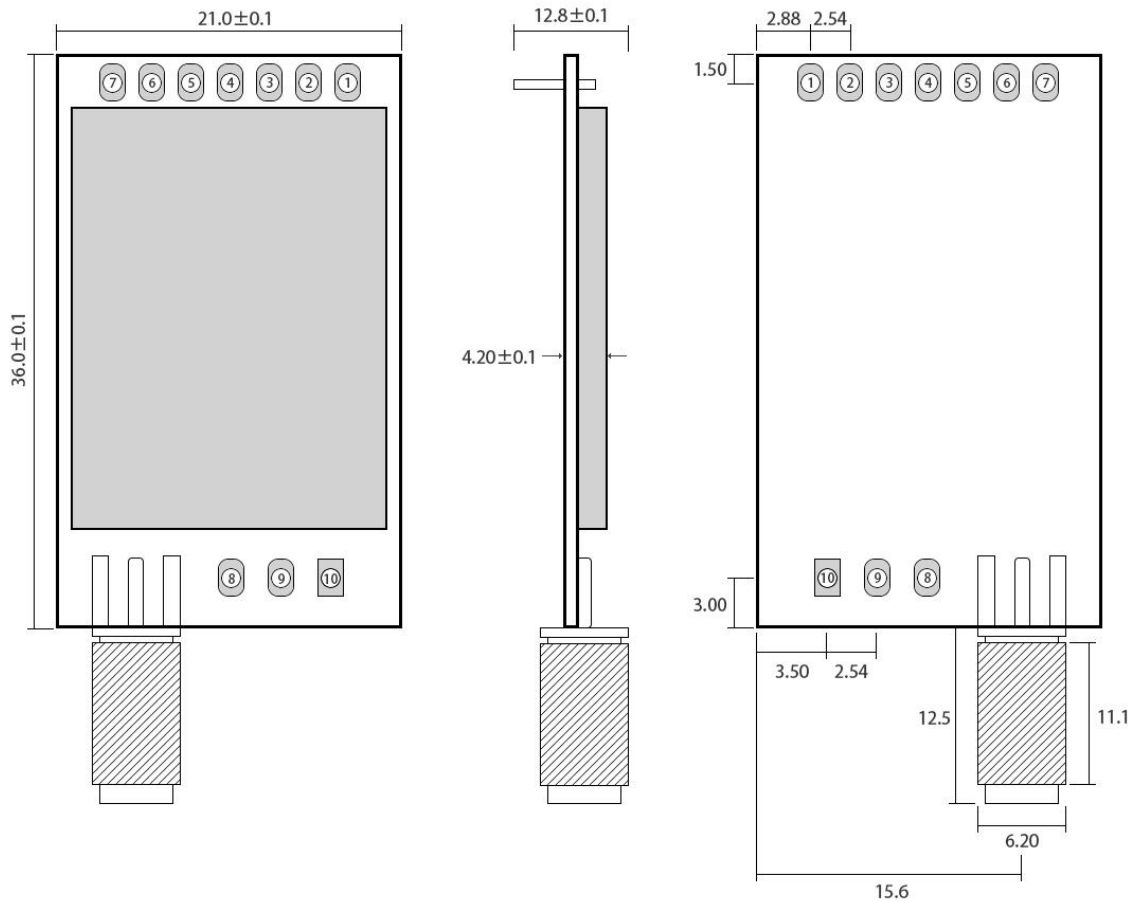

Pad quantity : 10
Unit: mm

No.	Name	Direction	Function
1	M0	Input (weak pull-up)	Work with M1 to decide 4 working modes of module (not suspended, if not used, could be grounded).
2	M1	Input (weak pull-up)	Work with M0 to decide 4 working modes of module (not suspended, if not used, could be grounded).
3	RXD	Input	TTL UART input, connects to external TXD output pin.
4	TXD	Output	TTL UART output, connects to external RXD input pin.
5	AUX	Output	To indicate module 's working status & wakes up the external MCU. During the procedure of self-check initialization, the pin outputs low level.

			(suspending is allowed).
6	VCC	Power supply	Module power supply positive reference, voltage range: 2.3 ~ 5.5V DC
7	GND	Power supply	Ground
8	Fixed hole		Fixed hole (Connect to GND on the module)
9	Fixed hole		Fixed hole (Connect to GND on the module)
10	Fixed hole		Fixed hole (Connect to GND on the module)

4. Connect to MCU

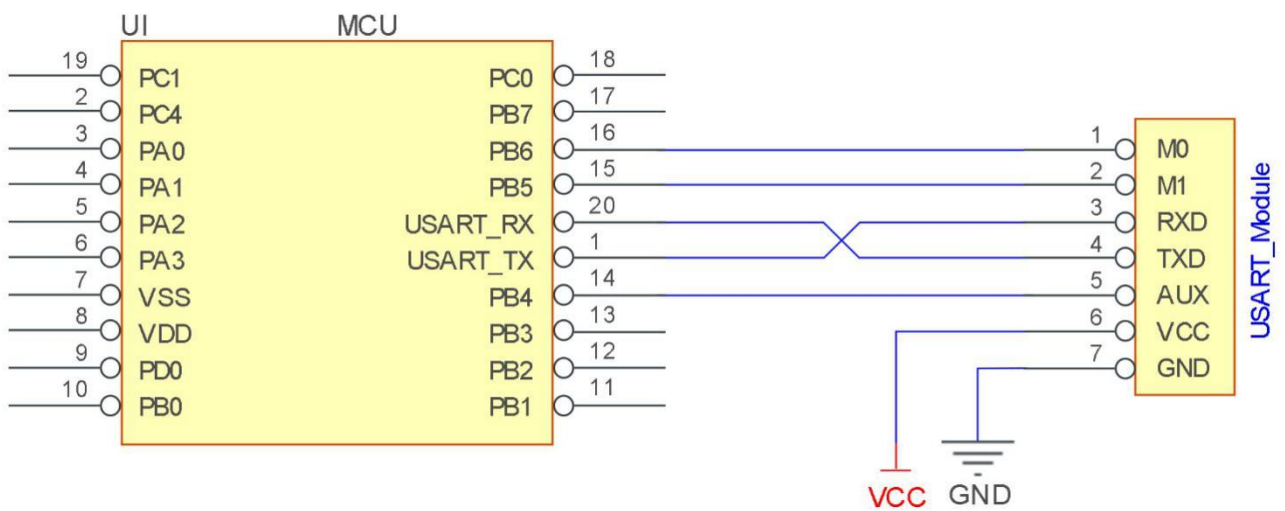

No.	Description (STM8L MCU)
1	The UART module is TTL level, please connect with TTL level MCU.
2	For some MCU works at 5V DC, it may need to add 4~10K pull-up resistor for the TXD & AUX pin.

5. Function description

5.1 Fixed transmission

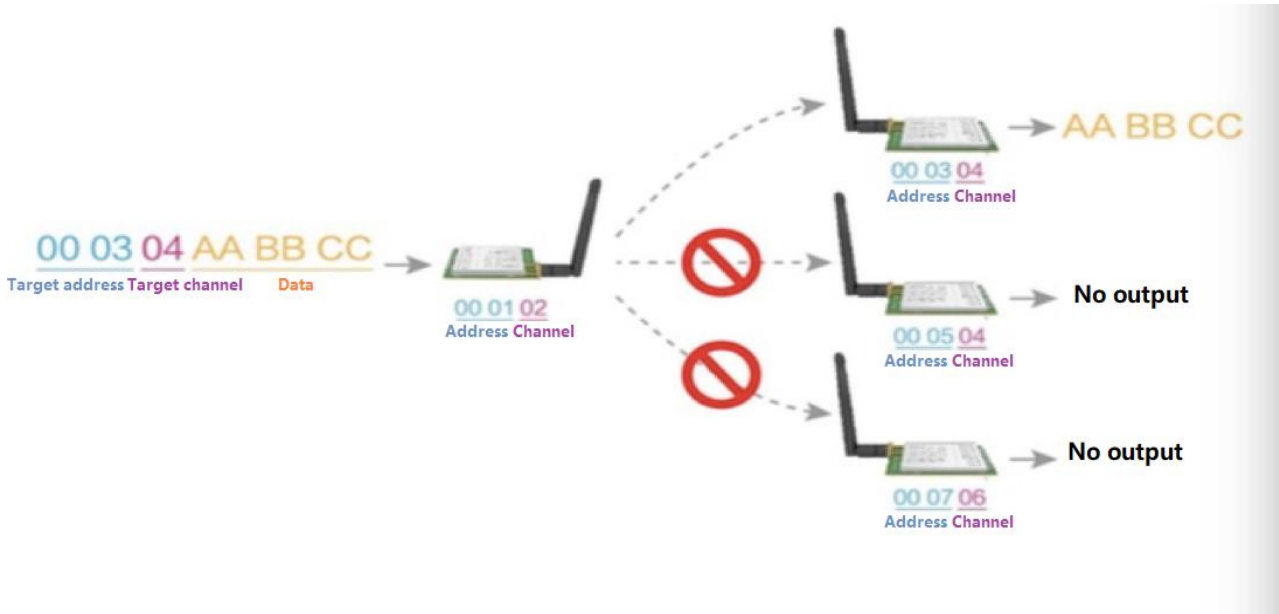

5.2 Broadcasting transmission



5.3 Broadcasting address

- For example: Set the address of module A as 0xFFFF, and the channel as 0x04;
- When module is the transmitter (transparent transmission), all modules under channel 0x04 will receive the data, the

purpose of broadcast is realized.

5.4 Monitor address

- For example: Set the address of module A as 0xFFFF, and the channel as 0x04;
- When module A is the receiver, it can receive the data sent from all modules under channel 0x04, the purpose of monitor is realized.

5.5 Reset

- When the module is powered on, AUX outputs low level immediately, conducts hardware self-check and sets the operating mode based on user's parameters. During the process, the AUX remains low level. After the process completed, the AUX outputs high level and starts to work as the operating mode combined by M1 and M0. Therefore, users need to wait the AUX rising edge as the start of module's normal work.

5.6 AUX description

- AUX Pin can be used as indication for wireless sending & receiving buffer and self-check.
- It can indicate whether there are data that are not sent yet via wireless way, or whether all wireless data has been sent through UART, or whether the module is still in the process of self-check initialization.

5.6.1 Indication of UART output

- To wake up external MCU

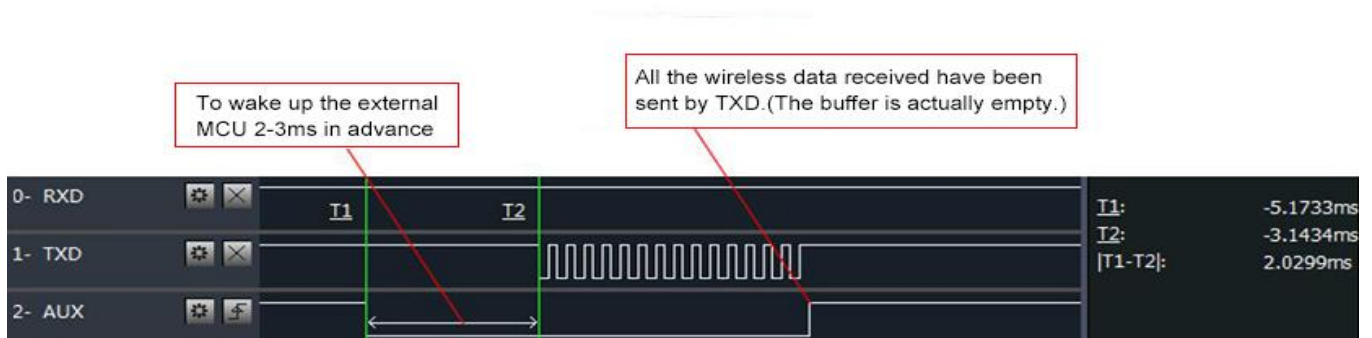

Timing Sequence Diagram of AUX when TXD pin transmits

5.6.2 Indication of wireless transmitting

- Buffer (empty): the internal 1000 bytes data in the buffer are written to the RFIC (Auto sub-packaging);
When AUX=1, users can input data less than 1000 bytes continuously without overflow;
When AUX=0, Buffer (not empty): the internal 1000 bytes data in the buffer have not been written to the RFIC completely. If users starts to transmit data at this circumstance, it may cause overtime when the module is waiting for the user data, or transmitting wireless sub package.

Note: When AUX = 1, it does not mean that all the UART data of the module have been transmitted already, maybe the last packet of data is still in transmission.

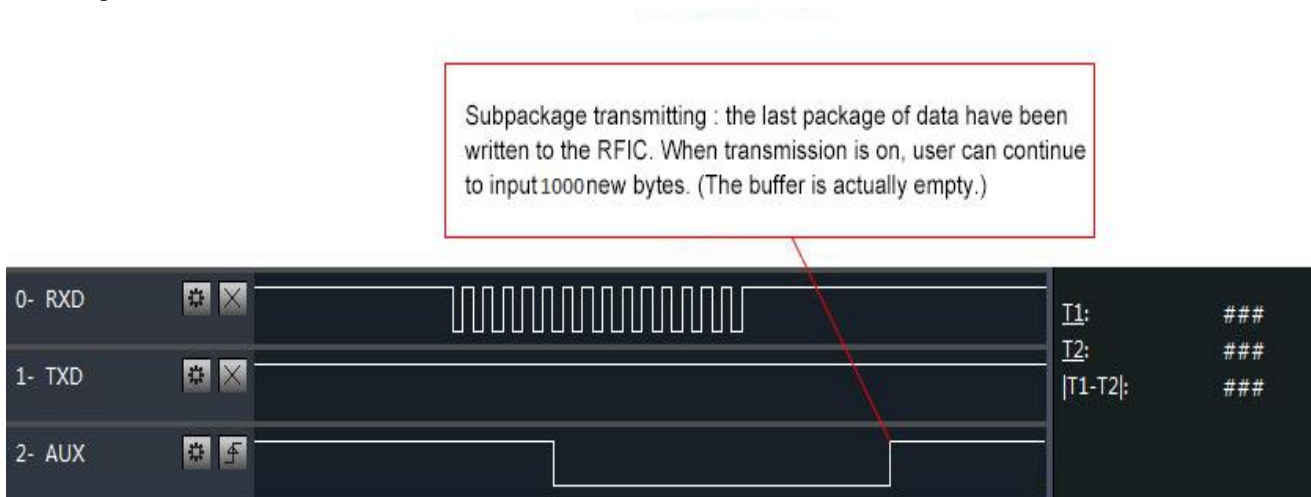

Timing Sequence Diagram of AUX when RXD pin receives

5.6.3 Configuration procedure of the module

- Only happened when power-on resetting or exiting sleep mode



Timing Sequence Diagram of AUX when self-check

5.6.4 Notes for AUX

No.	Description
1	For function 1 & function 2 mentioned above, the priority should be given to the one with low level output, which means if it meets each of any low level output condition, AUX outputs low level, if none of the low level condition is met, AUX outputs high level.
2	When AUX outputs low level, it means the module is busy & cannot conduct operating mode checking. Within 1ms since AUX outputs high level, the mode switch will be completed.
3	After switching to new operating mode, it will not work in the new mode immediately until AUX rising edge lasts for 2ms . If AUX stays on the high level, the operating mode switch takes effect immediately.

4	When users switch to other operating modes from mode 3 (sleep mode) or it's still in reset process, the module will reset user parameters, during which AUX outputs low level.
5	Due to the characteristics of the LoRa modulation method, the information transmission delay is much longer than FSK. For example, at 1.2kbps, the 100-byte transmission delay is about 1.5 seconds. It is recommended that customers do not transmit large amounts of data at low airspeed in order to avoid data loss caused by data accumulation and communication abnormalities.

6. Operating mode

There are four operating modes, which are set by M1 and M0, the details are as follows:

Mode(0-3)	M1	M0	Description	Remark
0 Transmission mode	0	0	UART and wireless channel are open, transparent transmission is on	Supports configuration over air via special command
1 WOR mode	0	1	Can be defined as WOR transmitter and WOR receiver	Supports wake up over air
2 Configuration mode	1	0	Users can access the register through the serial port to control the working state of the module	
3 Deep sleep mode	1	1	Sleep mode	

6.1 Mode switching

No.	Remark
1	<ul style="list-style-type: none"> Users can combine M1 and M0 with high and low levels to determine the operating mode. Two GPIOs of the MCU can be used to control mode switching; After changing M1 and M0: If the module is idle, after 1ms, it can start working according to the new mode; If the serial port data of the module has not been transmitted through the wireless, the new working mode can be switched after the transmission is completed; If the module receives the wireless data and transmits the data through the serial port, it needs to finish transmission before switching the new working mode; Therefore, mode switching can only be valid when AUX output 1, otherwise it will delay switching.
2	<ul style="list-style-type: none"> For example, users continuously input a large amount of data and simultaneously performs mode switching. At this time, the switching mode operation is invalid; the module will process all the user data before performing the new mode detection; Therefore, the general recommendation is to detect the output state of the AUX pin and switch after 2ms when the output is high level.
3	<ul style="list-style-type: none"> When the module is switched from other modes to sleep mode, if the data has not been processed yet; The module will process these data (including receiving and sending) before entering sleep mode. This feature can be used for fast sleep, which saves power; for example, the transmitter module works in mode 0, the user transmits the serial port data "12345", and then does not have to wait for the AUX pin to be idle (high level), and can directly switch to sleep mode. And the user's main MCU immediately sleeps, the module will automatically transmit the user data through the wireless, and automatically enters sleep within 1ms; This saves MCU's working time and reduces power consumption.

4	<ul style="list-style-type: none"> Similarly, any mode switching can use this feature. After the module processes the current mode event, it will automatically enter the new mode within 1ms; thus eliminating the need for the user to query AUX and achieve the purpose of fast switching; For example, switching from the transmit mode to the receive mode; the user MCU can also enter sleep before the mode switch, and use the external interrupt function to acquire the AUX change, thereby performing mode switching.
5	<ul style="list-style-type: none"> This operation mode is very flexible and efficient, and is designed according to the user's MCU's operation convenience, and can reduce the workload of the entire system as much as possible, improve system efficiency, and reduce power consumption.

6.2 Normal mode (Mode 0)

Type	M0 = 0, M1 = 0
Transmitting	Users can input data through the serial port and the module will start wireless transmission.
Receiving	The module wireless receiving function is turned on, and after receiving the wireless data, it will be output through the serial port TXD pin.

6.3 WOR mode (Mode 1)

Type	M0 = 1, M1 = 0
Transmitting	When defined as a transmitting party, a preamble is automatically added before transmitting.
Receiving	It can receive data normally, the receiving function is the same as mode 0.

6.4 Configuration mode (Mode 2)

Type	M0 = 0, M1 = 1
Transmitting	Wireless transmitting off
Receiving	Wireless receiving off
Configuration	Users can access the registers to configure the module's operation state.

6.5 Deep sleep mode (Mode 3)

Type	M0 = 1, M1 = 1
Transmitting	Unable to transmit wireless data
Receiving	Unable to receive wireless data
Note	When from the sleep mode to other modes, the module will reconfigure the parameters. During the configuration process, AUX will remain low; After configuration, it outputs high level, we suggest that user test rising edge AUX.

7. Register read and write control

7.1 Command format

In configuration mode (mode 2: M1 = 1, M0 = 0), the list of supported commands are as follows (only 9600, 8N1 format is supported when) :

No.	Command format	Description															
1	Set register	<p>Command: C0+starting address+length+parameters Response: C1+starting address+length+parameters</p> <p>E.g 1: Channel is 0x09</p> <table border="0"> <tr> <td></td> <td>command</td> <td>starting address</td> <td>length</td> <td>parameter</td> </tr> <tr> <td>Send:</td> <td>C0</td> <td>05</td> <td>01</td> <td>09</td> </tr> <tr> <td>Return:</td> <td>C1</td> <td>05</td> <td>01</td> <td>09</td> </tr> </table> <p>E.g 2: Configure module address (0x1234), network address (0x00), serial port (9600 8N1) and air data rate (1.2K). Send: C0 00 04 12 34 00 61 Return: C1 00 04 12 34 00 61</p>		command	starting address	length	parameter	Send:	C0	05	01	09	Return:	C1	05	01	09
	command	starting address	length	parameter													
Send:	C0	05	01	09													
Return:	C1	05	01	09													
2	Read register	<p>Command: C1+starting address+length Response: C1+starting address+length+parameters</p> <p>E.g 1 : Read channel</p> <table border="0"> <tr> <td></td> <td>command</td> <td>starting address</td> <td>length</td> <td>parameter</td> </tr> <tr> <td>Send:</td> <td>C1</td> <td>05</td> <td>01</td> <td></td> </tr> <tr> <td>Return:</td> <td>C1</td> <td>05</td> <td>01</td> <td>09</td> </tr> </table> <p>E.g 2: Read module address, network address, serial port and air data rate. Send: C1 00 04 Return: C1 00 04 12 34 00 61</p>		command	starting address	length	parameter	Send:	C1	05	01		Return:	C1	05	01	09
	command	starting address	length	parameter													
Send:	C1	05	01														
Return:	C1	05	01	09													
3	Set temporary registers	<p>Command: C2+starting address+length+parameters Response: C1+starting address+length+parameters</p> <p>E.g 1: Channel is 0x09</p> <table border="0"> <tr> <td></td> <td>command</td> <td>starting address</td> <td>length</td> <td>parameter</td> </tr> <tr> <td>Send:</td> <td>C2</td> <td>05</td> <td>01</td> <td>09</td> </tr> <tr> <td>Return:</td> <td>C1</td> <td>05</td> <td>01</td> <td>09</td> </tr> </table> <p>E.g 2: Configure module address (0x1234), network address (0x00), serial port (9600 8N1) and air data rate (1.2K). Send: C2 00 04 12 34 00 61</p>		command	starting address	length	parameter	Send:	C2	05	01	09	Return:	C1	05	01	09
	command	starting address	length	parameter													
Send:	C2	05	01	09													
Return:	C1	05	01	09													

		Return: C1 00 04 12 34 00 61															
5	Wireless configuration	<p>Command: CF CF + normal command Respond : CF CF + normal respond</p> <p>E.g 1: Channel is 0x09</p> <table border="1"> <thead> <tr> <th>Command head</th> <th>command</th> <th>starting address</th> <th>length</th> <th>parameter</th> </tr> </thead> <tbody> <tr> <td>Send: CF CF</td> <td>C0</td> <td>05</td> <td>01</td> <td>09</td> </tr> <tr> <td>Return: CF CF</td> <td>C1</td> <td>05</td> <td>01</td> <td>09</td> </tr> </tbody> </table> <p>E.g 2: Configure module address (0x1234), network address (0x00), serial port (9600 8N1) and air data rate (1.2K). Send: CF CF C2 00 04 12 34 00 61 Return: CF CF C1 00 04 12 34 00 61</p>	Command head	command	starting address	length	parameter	Send: CF CF	C0	05	01	09	Return: CF CF	C1	05	01	09
Command head	command	starting address	length	parameter													
Send: CF CF	C0	05	01	09													
Return: CF CF	C1	05	01	09													
6	Wrong format	Wrong format respond: FF FF FF															

7.2 Register description

Address	Read or write	Name	Description	Remark			
00H	Read/Write	ADDH	ADDH (default 0)	The module address is high byte and low byte. Note: When the module address is FFFF, it can be used as the broadcast and monitor address, that is the module will not perform address filtering.			
01H	Read/Write	ADDL	ADDL (default 0)				
02H	Read/Write	NETID	NETID (default 0)	Network address, used to distinguish the network. When communicating with each other, they should be set to the same.			
03H	Read/Write	REG0	7	6	5	UART Serial port rate (bps)	For the two modules that communicate with each other, the serial port baud rate can be different, and the parity method can also be different. When transmitting large packets continuously, users need to consider the data blocking caused by the same baud rate, and data may even be lost. It is generally recommended that both parties have the same baud rate.
			0	0	0	Serial port baud rate is 1200	
			0	0	1	Serial port baud rate is 2400	
			0	1	0	Serial port baud rate is 4800	
			0	1	1	Serial port baud rate is 9600 (default)	
			1	0	0	Serial port baud rate is 19200	
			1	0	1	Serial port baud rate is 38400	
			1	1	0	Serial port baud rate is 57600	
			1	1	1	Serial port baud rate is 115200	
			4	3	Serial parity bit		
			0	0	8N1 (default)		
			0	1	8O1		
			1	0	8E1		
			1	1	8N1 (equal to 00)		
			2	1	0	Wireless air data rate (bps)	The air rate of both communication parties must be the same; The higher the air rate, the smaller the delay and the shorter the transmission distance.
			0	0	0	Air data rate 0.3k	
0	0	1	Air data rate 1.2k				
0	1	0	Air data rate 2.4k (default)				
0	1	1	Air data rate 4.8k				

			1	0	0	Air data rate 9.6k					
			1	0	1	Air data rate 19.2k					
			1	1	0	Air data rate 38.4k					
			1	1	1	Air data rate 62.5k					
04H	Read/ Write	REG1	7	6	Sub packet setting			When the data is smaller than the sub packet length, the serial output of the receiving end is an uninterrupted continuous output.			
			0	0	240 bytes (default)						
			0	1	128 bytes			When the data is larger than the sub packet length, the receiving end serial port will output the sub packet.			
			1	0	64 bytes						
			1	1	32 bytes						
			5	RSSI Ambient noise enable					When enabled, the C0 C1 C2 C3 command can be sent in the transmitting mode or WOR transmitting mode to read the register. Register 0x00: Current ambient noise RSSI Register 0x01: RSII when the data was received last time. (Current channel noise is: dBm = - (256 - RSSI)) Command format: C0 C1 C2 C3 + starting address + read length Return: C1 + address + read length + read valid value E.g: send C0 C1 C2 C3 00 01 Return C1 00 01 RSSI(Address can only start from 00)		
			0	Disable (default)							
			1	Enable					Power and current are nonlinear, and power efficiency is highest at maximum power. The current does not decrease in proportion to the decrease in power.		
			4	3	2	Reserve					
			1	0	Transmitting power						
						0	0	22dBm (default)			
						0	1	17dBm			
						1	0	13dBm			
						1	1	10dBm			
05H	Read/ Write	REG2	Channel control (CH)				Frequency= 410.125 + CH *1M				
0-83 represents a total of 84 channels											
06H	Read/ Write	REG3	7	Enable RSSI				When enabled, the module receives wireless data and it will follow an RSSI strength byte after output via the serial port TXD.			
			0	Disable (default)							
			1	Enable				During fixed-point transmission,the module recognizes the first three bytes of the serial data as: address high + address low + channel and takes it as the wireless transmitting target.			
			6	transmission mode							
			0	Transparent transmission mode (default)							
			1	Fixed point transmission				After the reply function is enabled, if the target address is not the module itself, the module will forward it once.			
			5	Relay function							
			0	Disable repeater function (default)				In order to prevent data return-back, it is recommended to use it in conjunction with the fixed point mode. That is: the target address is different from the source address.			
			1	Enable repeater function							
			4	LBT enable							
			0	Disable (default)				When enabled, wireless data will be monitored before it is transmitted, which can avoid interference to a certain extent, but may cause			

			1	Enable			data delay. The maximum lingering time of LBT is 2 seconds, and it will be sent when it reaches 2 seconds.
			3	WOR transceiver control			Valid only for mode 1.
			0	WOR receiver (default) The module works in WOR monitoring mode. The monitoring period is as follows (WOR cycle), which can save a lot of power.			1. In the receiving mode of WOR, the module can modify the delay time after wake-up. Default time is 0;
			1	WOR transmitter The module receiving and transmitting functions are turned on, and a wake-up code is added when transmitting data.			2. The receiving end needs to send the command C0 09 02 03 E8 in configuration mode (C0 is the write command, 09 is the register initiator address, 02 is the length, 03 E8 is the set delay, the maximum FFFF is 65535ms, set to 0 turns off the wake-up delay); 3. Data can be sent within the delay.
			2	1	0	WOR period	Valid only for mode 1. Period T = (1 + WOR) * 500ms, maximum 4000ms, minimum 500ms The longer the WOR monitoring interval period, the lower the average power consumption, but the greater the data delay
			0	0	0	500ms	
			0	0	1	1000ms	
			0	1	0	1500ms	
			0	1	1	2000ms	
			1	0	0	2500ms	
			1	0	1	3000ms	
			1	1	0	3500ms	
			1	1	1	4000ms	
07H	Write	CRYPT_H	Key high byte (default 0)				Write only, read returns 0
08H	Write	CRYPT_L	Key low byte (default 0)				Used for user encryption to avoid intercepting airborne wireless data by similar modules. The module will internally use these two bytes as a calculation factor to transform and encrypt the over-the-air wireless signal.
80H~86H	Read	PID	Product information 7 bytes				Product information 7 bytes

7.3 Factory default parameter

No.	Factory default parameters: C0 00 09 00 00 00 62 00 17 03 00 00						
Model No.	Frequency	Address	Channel	Air data rate	Baud rate	Serial format	Power
E22-400T22D	433.125MHz	0x0000	0x17	2.4kbps	9600	8N1	22dbm

8. Repeater networking mode

No.	Description
1	After setting the repeater mode by configuration, switch to the normal mode and the repeater starts working.
2	In the repeater mode, ADDH, ADDL are no longer used as the module address, but is correspondingly paired with the NETID. If the data of one of the networks is received, it is forwarded to another network. The network ID of the repeater itself is invalid.
3	In repeater mode, the repeater module cannot transmit and receive data, and cannot perform low-power operation.
4	The user enters the other mode from mode 3 (sleep mode) or during the reset process, the module resets the user parameters during which the AUX outputs low level.

Repeater networking rules:

1. Forwarding rules, the repeater can forward data in both directions between two NETIDs.
2. In repeater mode, ADDH\ADDL is no longer used as the module address, and it is used as a NETID forwarding pairing flag.

Figure:

①Primary repeater

“Node 1” NETID is 08.

“Node 2” NETID is 33.

Primary repeater 1's 'ADDH\ADDL are 08, 33.

So the signal sent by node 1 (08) can be forwarded to node 2 (33)

At the same time, node 1 and node 2 have the same address, so the data transmitted by node 1 can be received by node 2.

②Secondary repeater

Secondary repeater's ADDH\ADDL are 33, 05.

Therefore, Repeater 2 can forward the data of Repeater 1 to the network NETID: 05.

Thus node 3 and node 4 can receive node 1 data. Node 4 outputs data normally, and node 3 has a different address than node 1, so no data is output.

③Two-way repeater

As shown in the figure: the data sent by node 1, the nodes 2, 4 can receive the data sent by node 2, 4, and node 1 can also receive it.

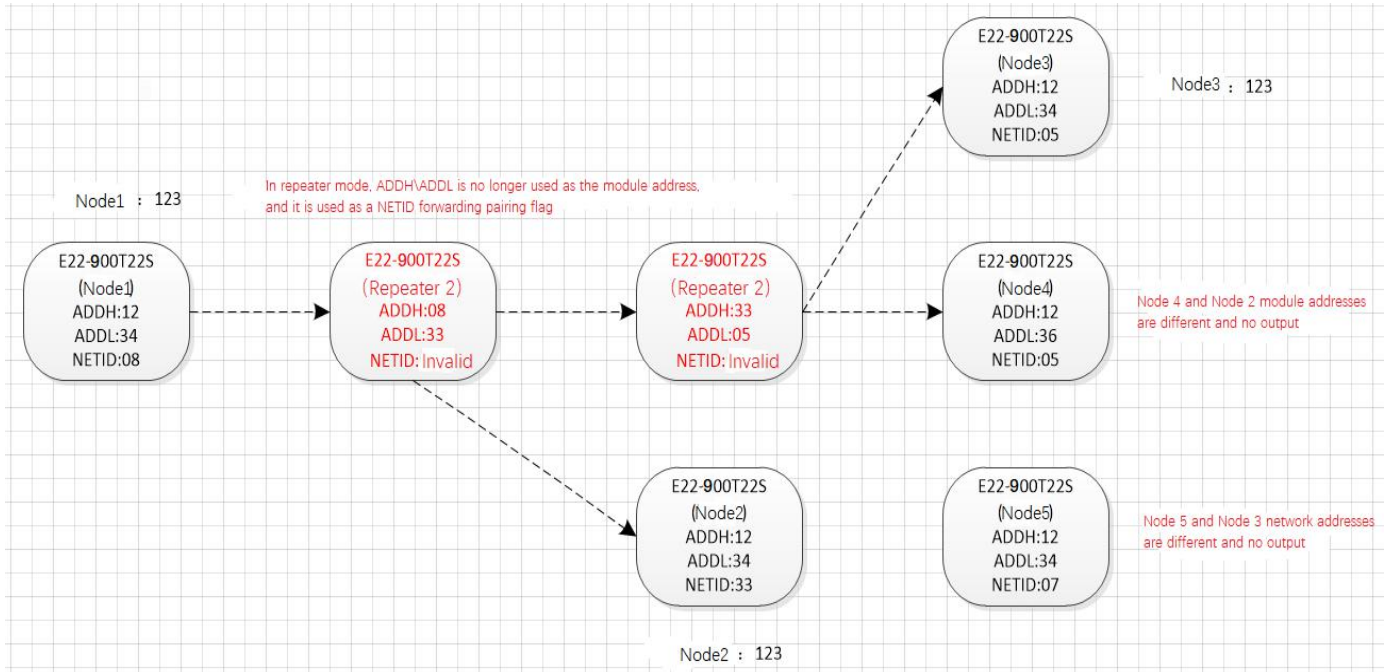

9. Configuration instructions on computer

- The following figure shows the E22-400T22D configuration host computer display interface, users can switch to the command mode through M0M1, and quickly configure and read the parameters on computer.



- In the configuration on computer, the module address, frequency channel, network ID, and key are all in decimal mode. The range of values of each parameter is:

Network address: 0-65535

Frequency channel: 0-83

Network ID: 0-255

Key: 0-65535

- When users configure the repeater mode using the host computer, special attention must be paid. Since the parameters are in decimal mode in the host computer, the module address and network ID need to be converted into hexadecimal.
- For example, if the network ID input by the transmitting end A is 02, and the network ID input by the receiving end B is 10, when the repeater end R sets the module address, the hexadecimal value 0X020A is converted into the decimal value 522 as the repeater end R. Module address.
- That is, the module address value of the repeater terminal R is 522 at this time.

10. Hardware design

- It is recommended to use a DC stabilized power supply. The power supply ripple factor is as small as possible, and the module needs to be reliably grounded.;
- Please pay attention to the correct connection of the positive and negative poles of the power supply. Reverse connection may cause permanent damage to the module;
- Please check the power supply to ensure it is within the recommended voltage otherwise when it exceeds the maximum value the module will be permanently damaged;
- Please check the stability of the power supply, the voltage can not be fluctuated frequently;
- When designing the power supply circuit for the module, it is often recommended to reserve more than 30% of the margin, so the whole machine is beneficial for long-term stable operation.;
- The module should be as far away as possible from the power supply, transformers, high-frequency wiring and other parts with large electromagnetic interference.;
- High-frequency digital routing, high-frequency analog routing, and power routing must be avoided under the module. If it is necessary to pass through the module, assume that the module is soldered to the Top Layer, and the copper is spread on the Top Layer of the module contact part(well grounded), it must be close to the digital part of the module and routed in the Bottom Layer;
- Assuming the module is soldered or placed over the Top Layer, it is wrong to randomly route over the Bottom Layer or other layers, which will affect the module's spurs and receiving sensitivity to varying degrees;
- It is assumed that there are devices with large electromagnetic interference around the module that will greatly affect the performance. It is recommended to keep them away from the module according to the strength of the interference. If necessary, appropriate isolation and shielding can be done;
- Assume that there are traces with large electromagnetic interference (high-frequency digital, high-frequency analog, power traces) around the module that will greatly affect the performance of the module. It is recommended to stay away from the module according to the strength of the interference.If necessary, appropriate isolation and shielding can be done.
- If the communication line uses a 5V level, a 1k-5.1k resistor must be connected in series (not recommended, there is still a risk of damage);

- Try to stay away from some physical layers such as TTL protocol at 2.4GHz , for example: USB3.0;
- The mounting structure of antenna has a great influence on the performance of the module. It is necessary to ensure that the antenna is exposed, preferably vertically upward.
- When the module is mounted inside the case, use a good antenna extension cable to extend the antenna to the outside;
- The antenna must not be installed inside the metal case, which will cause the transmission distance to be greatly weakened.

11. FAQ

11.1 Communication range is too short

- The communication distance will be affected when obstacle exists.
- Data lose rate will be affected by temperature, humidity and co-channel interference.
- The ground will absorb and reflect wireless radio wave, so the performance will be poor when testing near ground.
- Sea water has great ability in absorbing wireless radio wave, so performance will be poor when testing near the sea.
- The signal will be affected when the antenna is near metal object or put in a metal case.
- Power register was set incorrectly, air data rate is set as too high (the higher the air data rate, the shorter the distance).
- The power supply low voltage under room temperature is lower than 2.5V, the lower the voltage, the lower the transmitting power.
- Due to antenna quality or poor matching between antenna and module.

11.2 Module is easy to damage

- Please check the power supply source, ensure it is 2.0V~3.6V, voltage higher than 3.6V will damage the module.
- Please check the stability of power supply, the voltage cannot fluctuate too much.
- Please make sure antistatic measure are taken when installing and using, high frequency devices have electrostatic susceptibility.
- Please ensure the humidity is within limited range, some parts are sensitive to humidity.
- Please avoid using modules under too high or too low temperature.

11.3 BER(Bit Error Rate) is high

- There are co-channel signal interference nearby, please be away from interference sources or modify frequency and channel to avoid interference;
- Poor power supply may cause messy code. Make sure that the power supply is reliable.
- The extension line and feeder quality are poor or too long, so the bit error rate is high;

12. Welding guidance

This product is a DIP module. When welding the module, the welding personnel must operate in accordance with the anti-static operation specifications;

This product is electrostatic sensitive. Welding the module randomly without complying with the specifications may cause permanent damage to the module.

13. E22 series

Model No.	Core IC	Frequency Hz	Tx power dBm	Distance km	Package	Size mm	Interface
E22-230T22S	SX1262	230M	22	5	SMD	16*26	TTL
E22-230T30S	SX1262	230M	30	10	SMD	20*40.5	TTL
E22-400T22S	SX1268	433/470M	22	5	SMD	16*26	TTL
E22-400T22D	SX1268	433/470M	22	5	DIP	21*36	TTL
E22-400T30S	SX1268	433/470M	30	10	SMD	20*40.5	TTL
E22-900T22S	SX1262	868/915M	22	5	SMD	16*26	TTL
E22-900T30S	SX1262	868/915M	30	10	SMD	20*40.5	TTL
E22-400M22S	SX1268	433/470M	22	7	SMD	14*20	SPI
E22-400M30S	SX1268	433/470M	30	12	SMD	24*38.5	SPI
E22-900M22S	SX1262	868/915M	22	7	SMD	14*20	SPI
E22-900M30S	SX1262	868/915M	30	12	SMD	24*38.5	SPI

14. Antenna guidance

14.1 Antenna recommendation

Antenna is an important role in the communication process. Inferior antennas often have a huge impact on communication systems. Therefore, we recommend some antennas for wireless modules with excellent performance and reasonable price.

Model No.	Type	Frequency Hz	Interface	Gain dBi	Height	Cable	Function feature
TX433-NP-4310	Flexible antenna	433M	Welding	2.0	43.8*9.5	-	Built-in flexible FPC antenna

TX433-JZ-5	Rubber antenna	433M	SMA-J	2.0	52	-	Short straight & omnidirectional
TX433-JZG-6	Rubber antenna	433M	SMA-J	2.5	62	-	Short straight & omnidirectional
TX433-JW-5	Rubber antenna	433M	SMA-J	2.0	50	-	Flexible & omnidirectional
TX433-JWG-7	Rubber antenna	433M	SMA-J	2.5	75	-	Flexible & omnidirectional
TX433-JK-11	Rubber antenna	433M	SMA-J	2.5	110	-	Flexible & omnidirectional
TX433-JK-20	Rubber antenna	433M	SMA-J	3.0	210	-	Flexible & omnidirectional
TX433-XPL-100	Sucker antenna	433M	SMA-J	3.5	185	100	Small sucker antenna, cost-effective
TX433-XP-200	Sucker antenna	433M	SMA-J	4.0	190	200	Medium sucker antenna, low power consumption
TX433-XP-300	Sucker antenna	433M	SMA-J	6.0	965	300	Large sucker antenna, high gain
TX490-JZ-5	Rubber antenna	470/490M	SMA-J	2.0	50	-	Short straight & omnidirectional
TX490-XPL-100	Sucker antenna	470/490M	SMA-J	3.5	120	100	Small sucker antenna, cost-effective

Revision history

Version	Date	Description	Issued by
1.0	2019-12-21	Initial version	Ren
1.1	2020-04-15		du
1.2	2020-11-26	Error correction	Linson

About us

Technical support: support@cdebyte.com

Documents and RF Setting download link: www.ebyte.com

Thank you for using Ebyte products! Please contact us with any questions or suggestions: info@cdebyte.com

Fax: 028-64146160 ext. 821

Web: www.ebyte.com

Address: Innovation Center D347, 4# XI-XIN Road, Chengdu, Sichuan, China