

GP1A70R/GP1A71R

OPIC Photointerrupter with Encoder Functions

■ Features

1. 2-phase (A, B) digital output
2. Sensing accuracy
(GP1A70R Disk slit pitch : 1.14mm)
(GP1A71R Disk slit pitch : 0.7mm)
3. PWB mounting type
(Lead bending type)
4. TTL compatible output
5. Compact, lightweight

■ Applications

1. Printers
2. Copiers
3. Numerical control machines

■ Outline Dimensions

(Unit : mm)

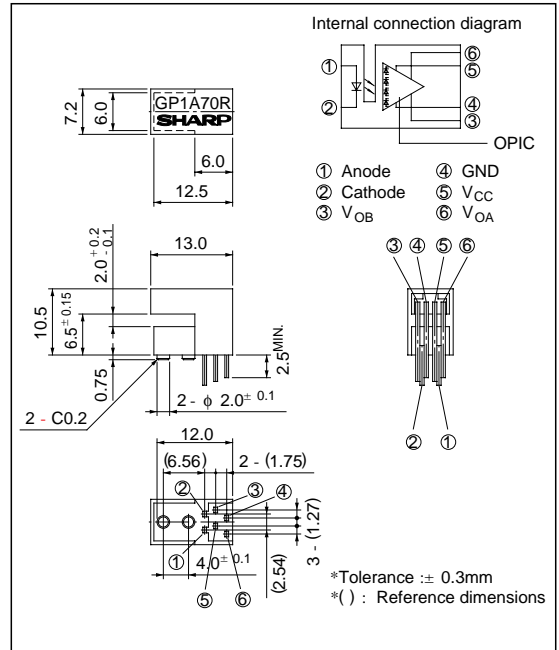

**"OPIC" (Optical IC) is a trademark of the SHARP Corporation.
An OPIC consists of a light-detecting element and signal-processing circuit integrated onto a single chip.

■ Absolute Maximum Ratings

(T_a = 25°C)

	Parameter	Symbol	Rating	Unit
Input	Forward current	I _F	50	mA
	^{*1} Peak forward current	I _{FM}	1	A
	Reverse voltage	V _R	6	V
	Power dissipation	P	75	mW
Output	Supply voltage	V _{CC}	7	V
	Low level output current	I _{OL}	20	mA
	Power dissipation	P _O	250	mW
	Operating temperature	T _{opr}	0 to + 70	°C
	Storage temperature	T _{stg}	- 40 to + 80	°C
	^{*2} Soldering temperature	T _{sol}	260	°C

*1 Pulse width ≤ 100μs, Duty ratio 0.01

*2 For 5 seconds

Electro-optical Characteristics

(Ta = 25°C unless otherwise specified)

Parameter		Symbol	Conditions	MIN.	TYP.	MAX.	Unit
Input	Forward voltage	V_F	$I_F = 20\text{mA}, T_a = 25^\circ\text{C}$	-	1.2	1.4	V
	Reverse current	I_R	$V_R = 3\text{V}, T_a = 25^\circ\text{C}$	-	-	10	μA
Output	Operating supply voltage	V_{CC}		4.5	5.0	5.5	V
	High level output voltage	V_{OH}	^{*3} $V_{CC} = 5\text{V}, I_F = 20\text{mA}$	2.4	4.9	-	V
	Low level output voltage	V_{OL}	^{*3} $I_{OL} = 8\text{mA}, V_{CC} = 5\text{V}, I_F = 20\text{mA}$	-	0.1	0.4	V
	Supply current	I_{CC}	^{*4} $V_{CC} = 5\text{V}, I_F = 20\text{mA}$	-	5	20	mA
	Duty ratio	GP1A70R GP1A71R	^{*5} D_A, D_B	^{*3} $V_{CC} = 5\text{V}, I_F = 20\text{mA}, f = 2.5\text{kHz}$	25	50	75
Transfer characteristics	Response frequency	$f_{MAX.}$	^{*3} $V_{CC} = 5\text{V}, I_F = 20\text{mA}$	-	-	10	kHz

*3 Measured under the condition shown in Measurement Conditions.

*4 In the condition that output A and B are low level.

*5 $D_A: \frac{t_{AH}}{t_{AP}} \times 100, D_B: \frac{t_{BH}}{t_{BP}} \times 100$, Duty ratio: Average disk rotation time per turn

Output Waveforms

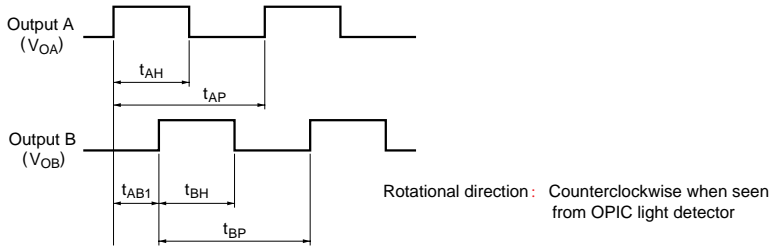

Fig. 1 Forward Current vs. Ambient Temperature

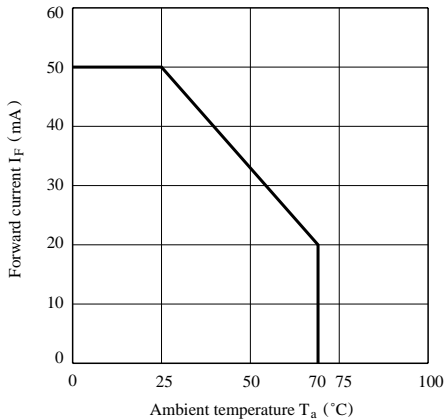

Fig. 2 Output Power Dissipation vs. Ambient Temperature

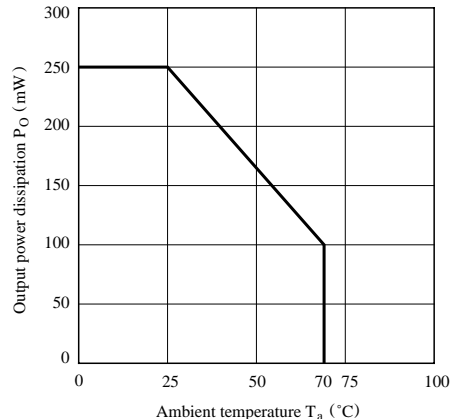

Fig. 3-a Duty Ratio vs. Frequency (GP1A70R)

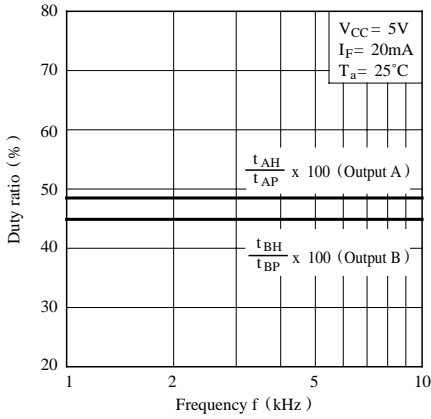

Fig. 3-b Duty Ratio vs. Frequency (GP1A71R)

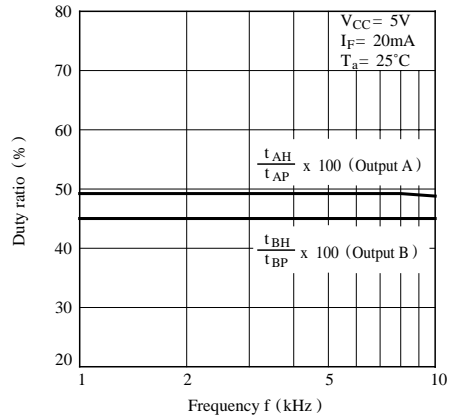

Fig. 4-a Phase Difference vs. Frequency (GP1A70R)

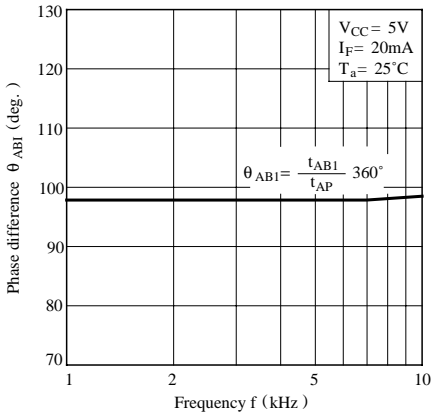

Fig. 4-b Phase Difference vs. Frequency (GP1A71R)

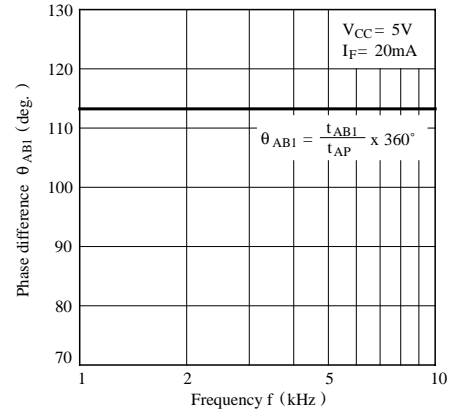

Fig. 5-a Duty Ratio vs. Ambient Temperature (GP1A70R)

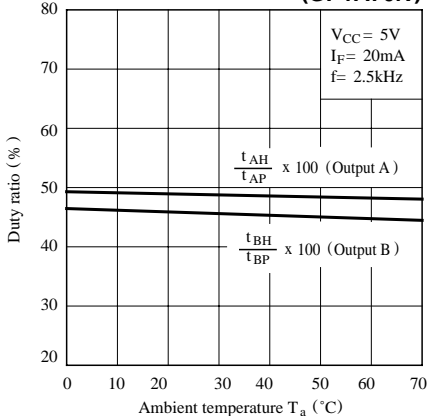

Fig. 5-b Duty Ratio vs. Ambient Temperature (GP1A71R)

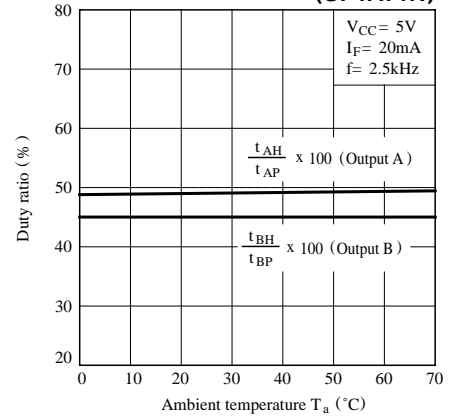

Fig. 6-a Phase Difference vs. Ambient Temperature

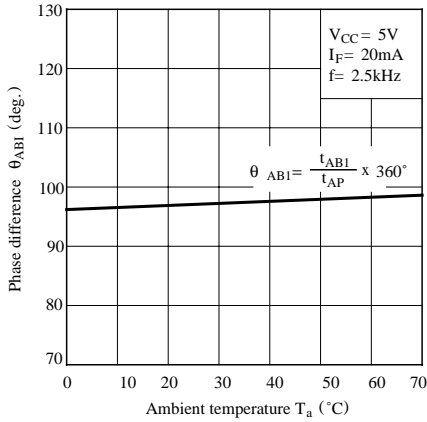

Fig. 6-b Phase Difference vs. Ambient Temperature

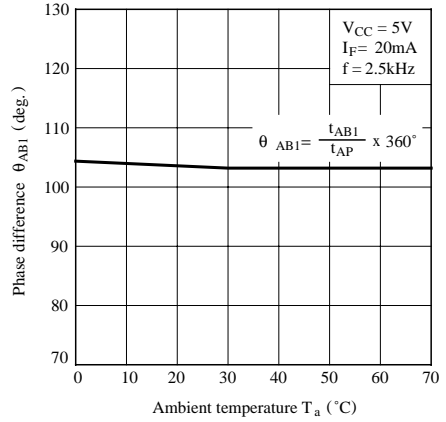

Fig. 7-a Duty Ratio vs. Distance (Xdirection)

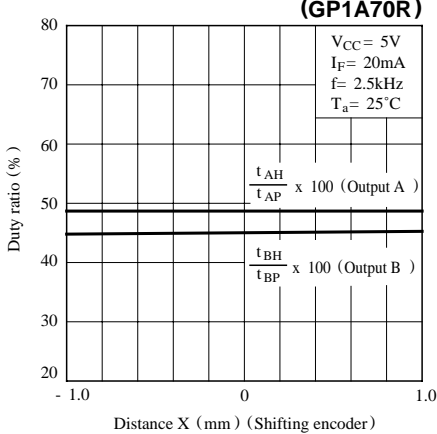

Fig. 7-b Duty Ratio vs. Distance (X direction)

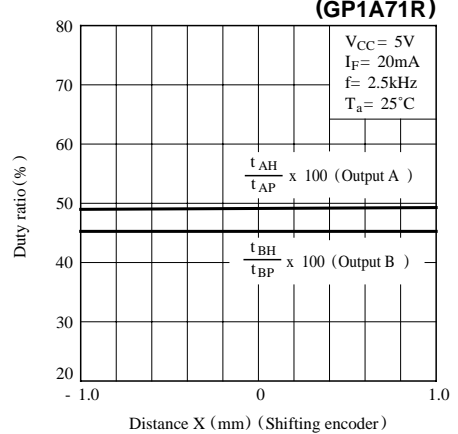

Fig. 8-a Phase Difference vs. Distance (X direction)

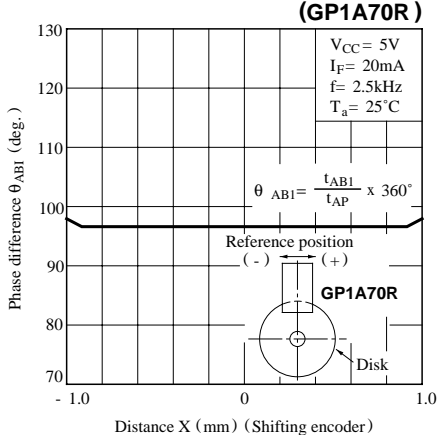

Fig. 8-b Phase Difference vs. Distance (X direction)

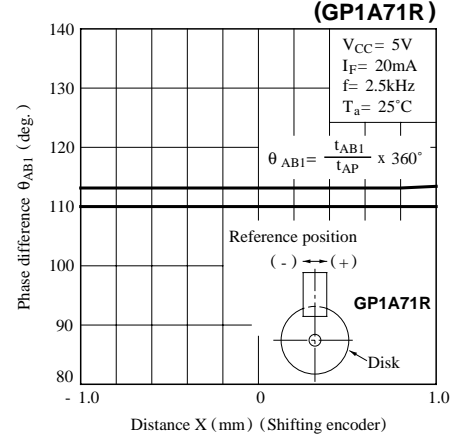

Fig. 9-a Duty Ratio vs. Distance (Ydirection) (GP1A70R)

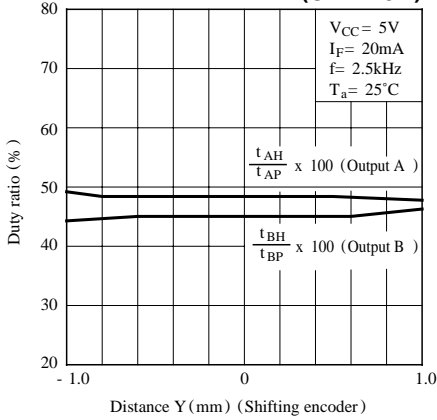

Fig. 9-b Duty Ratio vs. Distance (Y direction) (GP1A71R)

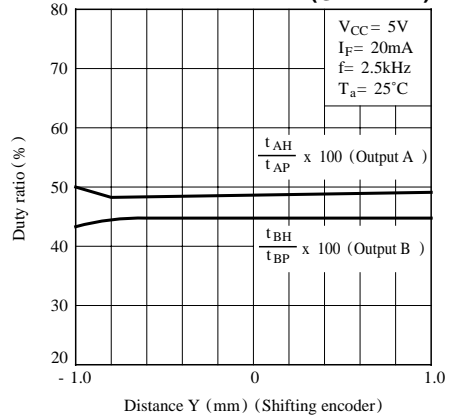

Fig.10-a Phase Difference vs. Distance (Y direction) (GP1A70R)

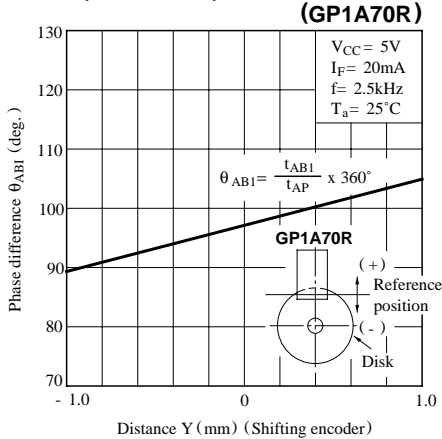

Fig.10-b Phase Difference vs. Distance (Y direction) (GP1A71R)

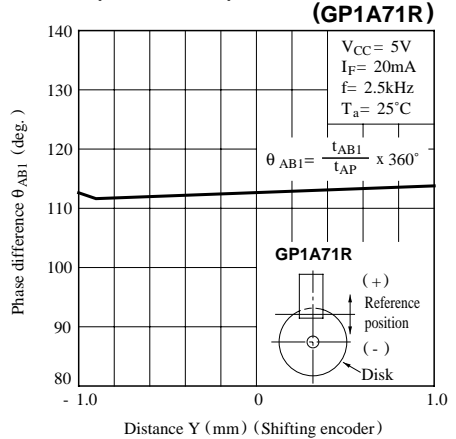

Fig.11-a Duty Ratio vs. Distance (Z direction) (GP1A70R)

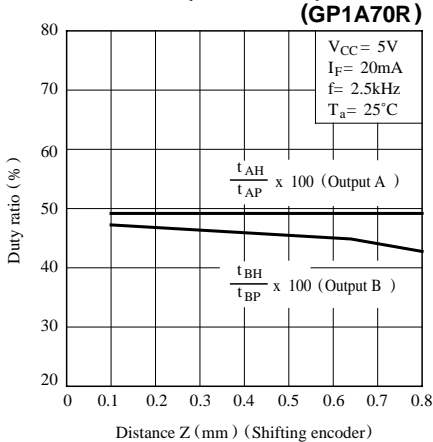

Fig.11-b Duty Ratio vs. Distance (Z direction) (GP1A71R)

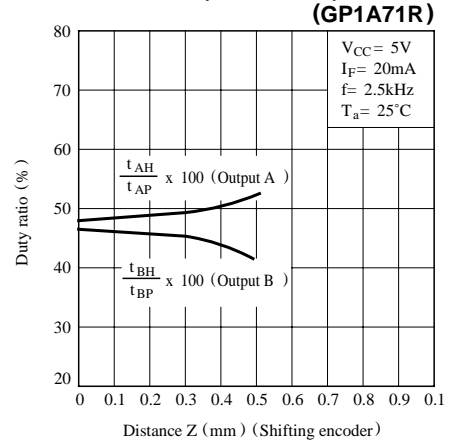

Fig.12-a Phase Difference vs. Distance
(Z direction)

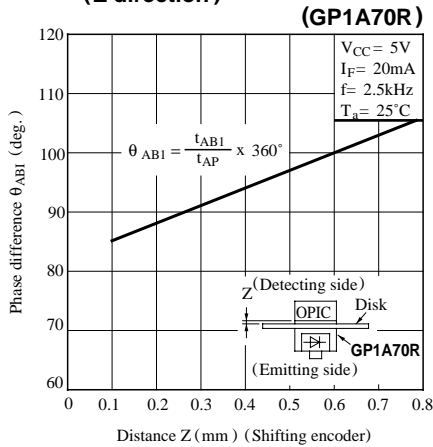
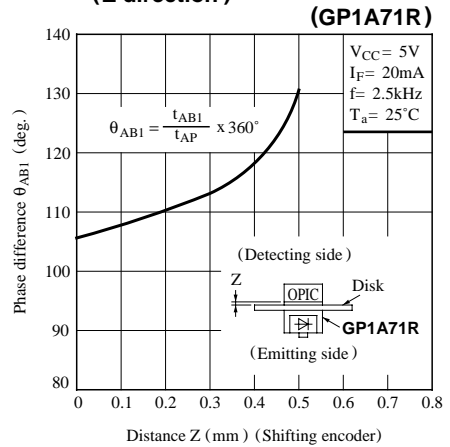
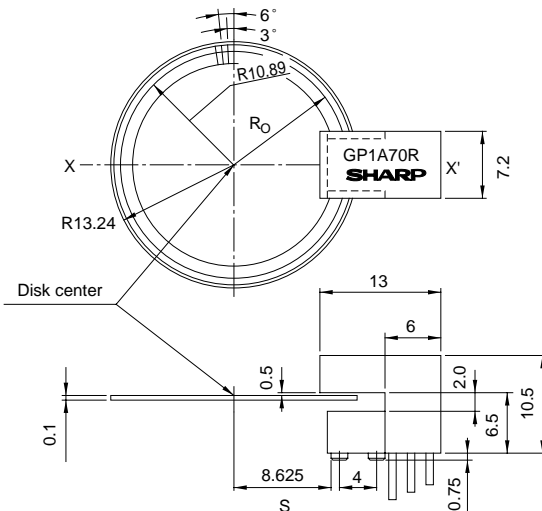

Fig.12-b Phase Difference vs. Distance
(Z direction)



<Measurement Conditions> (Unit : mm)



<GP1A70R Basic Design>

R_0 (distance between the disk center and half point of a slit) and S (installing position of GP1A70R) will be provided by the following equations.

$$R_0 = N/60 \times 10.89 \text{ (mm)} \quad N: \text{ number of slits}$$

$$S = R_0 - 2.265 \text{ (mm)}$$

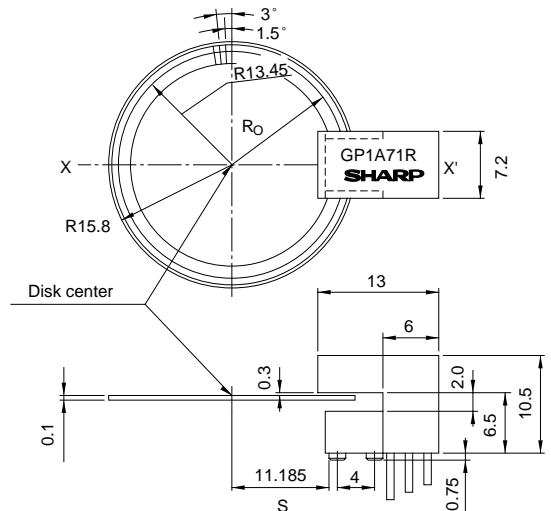

<GP1A71R Basic Design>

R_0 (distance between the disk center and half point of a slit) and S (installing position of GP1A71R) will be provided by the following equations.

$$R_0 = N/120 \times 13.45 \text{ (mm)} \quad N: \text{ number of slits}$$

$$S = R_0 - 2.265 \text{ (mm)}$$

■ Precautions for Use

- (1) This device is designed to be used under the condition of $I_F = 20mA$
- (2) It is recommended that a by-pass capacitor of more than $0.01\mu F$ be added between V_{CC} and GND near the device in order to stabilize power supply line.
- (3) As for other general cautions, refer to the chapter "Precautions for Use".

NOTICE

- The circuit application examples in this publication are provided to explain representative applications of SHARP devices and are not intended to guarantee any circuit design or license any intellectual property rights. SHARP takes no responsibility for any problems related to any intellectual property right of a third party resulting from the use of SHARP's devices.
- Contact SHARP in order to obtain the latest device specification sheets before using any SHARP device. SHARP reserves the right to make changes in the specifications, characteristics, data, materials, structure, and other contents described herein at any time without notice in order to improve design or reliability. Manufacturing locations are also subject to change without notice.
- Observe the following points when using any devices in this publication. SHARP takes no responsibility for damage caused by improper use of the devices which does not meet the conditions and absolute maximum ratings to be used specified in the relevant specification sheet nor meet the following conditions:
 - (i) The devices in this publication are designed for use in general electronic equipment designs such as:
 - Personal computers
 - Office automation equipment
 - Telecommunication equipment [terminal]
 - Test and measurement equipment
 - Industrial control
 - Audio visual equipment
 - Consumer electronics
 - (ii) Measures such as fail-safe function and redundant design should be taken to ensure reliability and safety when SHARP devices are used for or in connection with equipment that requires higher reliability such as:
 - Transportation control and safety equipment (i.e., aircraft, trains, automobiles, etc.)
 - Traffic signals
 - Gas leakage sensor breakers
 - Alarm equipment
 - Various safety devices, etc.
 - (iii) SHARP devices shall not be used for or in connection with equipment that requires an extremely high level of reliability and safety such as:
 - Space applications
 - Telecommunication equipment [trunk lines]
 - Nuclear power control equipment
 - Medical and other life support equipment (e.g., scuba).
- Contact a SHARP representative in advance when intending to use SHARP devices for any "specific" applications other than those recommended by SHARP or when it is unclear which category mentioned above controls the intended use.
- If the SHARP devices listed in this publication fall within the scope of strategic products described in the Foreign Exchange and Foreign Trade Control Law of Japan, it is necessary to obtain approval to export such SHARP devices.
- This publication is the proprietary product of SHARP and is copyrighted, with all rights reserved. Under the copyright laws, no part of this publication may be reproduced or transmitted in any form or by any means, electronic or mechanical, for any purpose, in whole or in part, without the express written permission of SHARP. Express written permission is also required before any use of this publication may be made by a third party.
- Contact and consult with a SHARP representative if there are any questions about the contents of this publication.